



# OPITEK FLEX FIX™

## UNIVERSAL FLEXIBLE POSITIONING DEVICE

**Instructions for use**

**NOT STERILE**





## Explanation of symbols on labels and packaging



Manufacturer



Date of production



LOT/serial number



Catalogue/item number



Single use only



NB: See the instructions



Read the instructions



Medical devices, class I (MDR)



Latex-free product



Unique device identification



Medical device

### Manufacturer:

Opitek International  
Gøngehusvej 252  
2950 Vedbæk  
Denmark

Telephone: +45 39 66 16 44  
Email: [info@opitek.dk](mailto:info@opitek.dk)

### For ordering parts and maintenance:

[www.opitek-international.dk](http://www.opitek-international.dk) - [info@opitek.dk](mailto:info@opitek.dk)



## Instructions for universal flexible positioning device

### Device name

The trade mark of the device is **Opitek Flex Fix (Flex Fix in this document)**. The generic device name is **Universal Flexible Positioning Device**

### Description

Before and during surgery, Flex Fix allows the surgical team to flexibly, yet precisely and stably, position the patient on the operating table.

Flex Fix can be used on patients in supine, lateral, lithotomy or prone position, as well as for (arm) support for assisting staff (e.g. speculum or scope restraint procedures)

One of the Flex Fix models is intended for use with a disposable cushion (one cushion per patient/procedure) for increased hygiene (preventing patient-to-patient transmission of contamination), comfort and patient safety.

Flex Fix is mounted on the side rail of the operating table and is not specific to a certain type of operating table.

### THE PRINCIPLES OF FLEX FIX FUNCTION

Flex Fix uses a support cushion mounted on a unique articulated arm (so-called FISSO arm) that works by unlocking three movable joints on the arm with a single movement of a swivel wheel. Flex Fix can then be adjusted to the desired support point on the patient, regardless of how the patient is positioned. Once the desired support point is found, fix the articulated arm with the swivel wheel and the positioning process is complete.

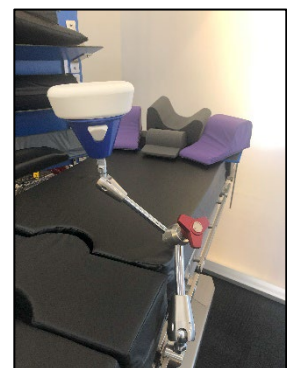

### Indication(s)

Flex Fix is particularly useful for procedures where the patient needs to be supported on or in a specific (smaller) area of the body and where a strong fixation of the patient is required.

General surgical procedures that involve positioning in the lateral, supine, prone or lithotomy position.

Use of surgical equipment that is supported or manually held by staff during surgery and where physical relief provided by this support is desired.

Where hygienic considerations play a role in the selection of the positioning device.



## Contraindication(s)

Patients with damaged skin in the area where the support touches the skin (necrosis, hypersensitivity, wounds, etc.).

## Warnings



- Always support the patient when positioning or changing the position of Flex Fix. Failure to support the patient can result in serious injury to the patient.
- After repositioning, check that the patient's position and stability, as well as the attachment of the equipment, is secure and has been verified by the surgeon before starting covering.
- Use only with special disposable cushions (for fitted models). When reusing disposable cushions, the risk of cross-contamination (transfer of biological substances from patient to patient) cannot be ruled out.
- Do not sterilise. The device is supplied unsterile and has not been tested against sterilisation procedures. Sterilisation can lead to malfunction of the fixation and adjustment devices, which in turn can result in serious injury to patients.
- To reduce the risk of skin being pinched, ensure that no excess or loose skin is placed or trapped between holders, cushions, or the mattress and stainless-steel parts.
- All handling should be done with as little force as possible and as much force as necessary.
- Do not lean on or against the support. Leaning against the support can damage the built-in safety features of the locking mechanisms and result in the cushion no longer being correctly positioned. This can cause patient- and skin injuries.
- The articulated arm can transfer electrical current and heat to the patient. Avoid contact between the articulated arm and any power or heat sources.
- Always follow the described sequence when positioning the patient. This is important for both patient safety and accurate positioning.

## Precautions

- Installation and handling of the products must be done manually and without the use of additional tools (except for the installation of upgrade kits – see below)
- Assembly, installation or adjustment of Flex Fix should only be carried out by personnel who are trained to do so.
- Improper handling may cause injury to the patient and/or damage to the products. When handling contaminated or biohazardous components/materials, the general precautions must be observed.

## Side effects

- There is a small risk of slight pressure marks. These marks are often slightly reddish in colour and will disappear within the first few hours after surgery. This can also occur due to skin conditions which result in hypersensitivity.

### - **Note regarding serious incidents:**

For a patient/user/third party in the European Union and countries with an identical regulatory framework (Medical Devices Regulation 2017/745/EU). If a serious incident has occurred during or as a result of the use of this device, it must be reported to the manufacturer and the national authority.

Content/product parts needed for a table are available in two basic versions:

- 1) Fixed support cushion system
- 2) System prepared for a disposable cushion

Upgrade kits between the two basic versions can be purchased



**Flex Fix complete system with fixed support cushion, item number 2024-01**  
Consisting of: Reusable cushion, articulated arm, rail clamp



**Flex Fix upgrade kit, from reusable to disposable cushion, item number 2024-100**  
Consisting of: Cushion holder, 12 mm adapter

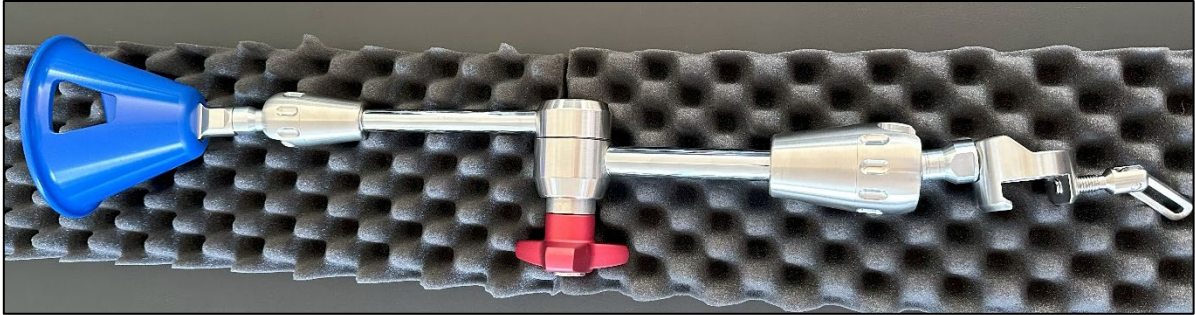

**Flex Fix complete system prepared for disposable cushion, item number 2024-200**  
**Consisting of: Cushion holder, articulated arm, rail clamp**



**Disposable support cushion, item number 2015-02**



**Flex Fix Upgrade Kit, from disposable to reusable cushion, item number 2024-150**  
**Consisting of: Reusable cushion, 12 mm adapter**



### Inspection on receipt

Immediately upon receipt, the product must be checked for any transport damage and completeness. Complaints can only be considered if the seller or carrier is notified immediately. In this case, a damage report must be sent immediately to the nearest Opitek International representative or to the Opitek International company.



**WARNING!**

Do not use if the packaging is damaged.

### Mounting the Flex Fix system on the operating table

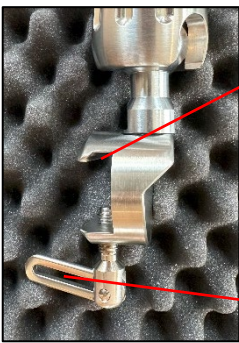

Pos. 2

The rail clamp is mounted on the side rail of the operating table and fixed by turning the mounting screw (pos. 1) clockwise from the bottom. During attachment, make sure that the top hook (pos. 2) grips behind the rail. Check that the rail clamp is securely and firmly fixed to the side rail.

Pos. 1



**WARNING!**

If the rail clamp is not properly secured, the component may become loose and cause injury to the patient.

### Disposable cushion fitting (if supplied)

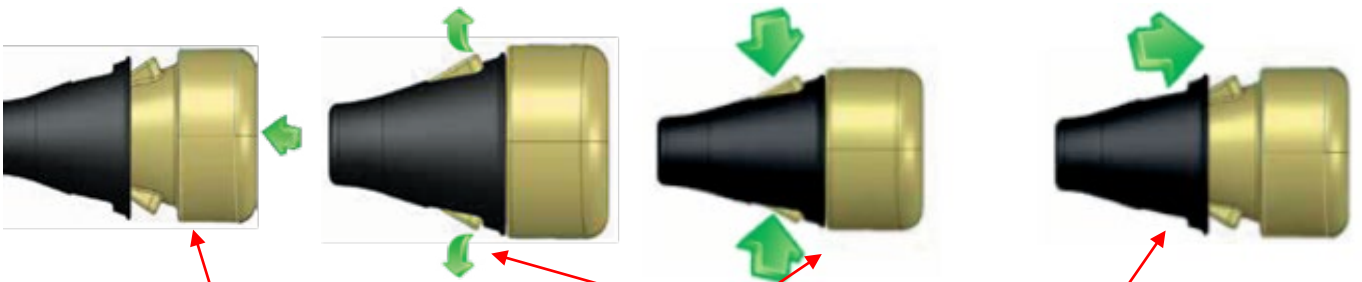

Push the cushion horizontally into the cushion holder and check that the "wings" fill the cut-outs in the holder.

### Dismantling

Dismantling of Flex Fix must be carried out without the use of additional tools and in the reverse order of installation. Hold the support cushion with one hand while loosening the mounting screw on the rail clamp with the other. Remove the splint clamp from the rail on the operating table. Remove the disposable cushions by pressing the "wings" in the cut-outs on the holders. Then pull the cushion out of the holder and dispose of it. The cushions are disposable.

## Handling articulated arms

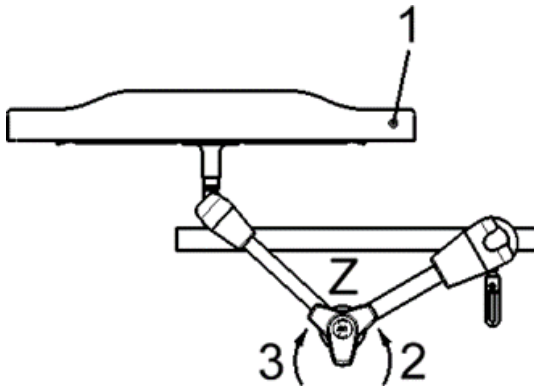

### Restraint, release, positioning, fixation, control:

1. Hold the articulated arm with one hand in the front segment (1) and operate the central clamping knob (Z) with the other hand.
2. To loosen, turn the central clamping knob (Z) anti-clockwise (2) as far as necessary
3. Move the articulated arm to the desired position.
4. To fix, turn the central clamping knob (Z) clockwise (3).
5. Control: Check that the articulated arm is firmly tightened and functioning properly.



### DANGER!

- If the articulated arm is not tightened correctly, it can loosen and move, causing serious injury.
- Avoid putting too much weight on the articulated arm.
- The articulated arm can transfer electrical current and heat to the patient. Avoid contact between the articulated arm and any power or heat sources.
- Avoid over-tightening the centre clamping knob (use only one hand and no tools). The articulated arm may move unintentionally if the central clamping knob is loosened.
- Always hold Flex Fix with one hand and operate the central clamping knob (Z) with the other.
- A damaged product can lead to serious injury.
- Only use products in perfect condition and check their function.



### WARNING!

- Keep hands and feet away from the joints during tightening. There is a risk of injury.
- Keep hands and feet away from joints during loosening and transport, which can potentially cause injuries.
- When transporting patients with a swing-out arm holder, be aware of possible collision risks.
- If possible, Flex Fix should be placed parallel to the table.
- Flex Fix is designed for a **maximum load of 155 Nm (approx. 15 kg)** when used as intended
- **The specified maximum load must not be exceeded.**



### NB!

- The fixation of the articulated arm is based on the friction principle. Changing the position without loosening the clamping mechanism can cause damage and will shorten the service life of the articulated arm.
- The articulated arm can be adjusted with very little force. If the centre clamping knob (Z) has been fully released, turn it clockwise.
- Residues of physiological salt solution (e.g. sodium chloride) can attack the metal surface. The saline solution must not come into contact with the product or penetrate the articulated arm.



### Mounting upgrade kits

Upgrade kits (item number 2024-100 or 2024-150) are mounted on the articulated arm's 12 mm threaded pin at the opposite end of the rail clamp.

Do not use thread adhesive (Loctite or similar). Tighten by hand (as little as possible – as much as necessary)

Use 2 x 16-17 mm single-headed spanners (item number 495-378, available separately).

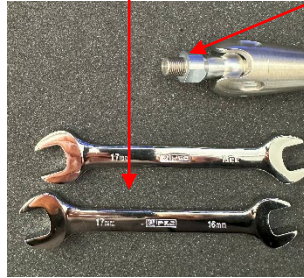

### Upgrade with item number 2024-100 from reusable to disposable cushion



Loosen the cushion by turning anti-clockwise



Separate the cushion from the articulated arm



Upgrade kit 2024-100 ready to mount



The cushion holder is secured by turning clockwise

### Upgrade with item number 2024-150 from disposable to reusable cushion



Release the cushion holder by turning anti-clockwise



Separate the cushion holder from the articulated arm



Upgrade kit 2024-150 ready to mount

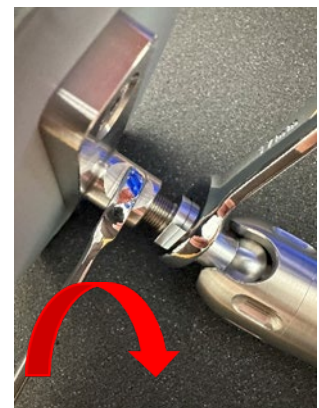

Secure the cushion by turning clockwise

## Treatment

All devices must be cleaned and sanitised before each use. This is also required for the first use after delivery of the device (cleaning and disinfection after removing the protective packaging). Effective cleaning and disinfection is a mandatory requirement for the safe use of the products.

The user is responsible for the safe use of the product. Therefore, it must be ensured that only sufficient product-specific validated procedures are used for cleaning and disinfection and that the validated parameters are used for each cycle.

Furthermore, you should be aware of applicable national legal regulations as well as hygiene regulations for medical centres or hospitals.



### **Danger!**

The product is supplied unsterile and cannot be sterilised. Before the first and all subsequent uses, the product must be cleaned and disinfected in accordance with the instructions in this manual and checked for visible irregularities and malfunctions.



### **NB!**

Material damage due to improper cleaning and disinfection.

This product should only be cleaned and disinfected **manually**. Cleaning and disinfecting agents must be compatible with the product.

### **Metallic surfaces**

Only use cleaning and disinfecting wipes. Never use metal brushes or steel wool.

### **Viscoelastic cushions**

- Wipe off with a soft damp cloth.

Products that should be avoided at all costs:

- Undiluted alcohol and/or acetone
- Perchloroethylene, trichloroethylene and wax
- Abrasive cleaners

Mechanically damaged cushions with cracks and cuts must be replaced immediately with new cushions to prevent moisture ingress (the hygienic conditions are no longer met).

Do not expose products to temperatures above 55°C (131°F).



### **WARNING!**

Explosion hazard.

Alcohol-containing agents form flammable mixtures that can lead to explosions when used with high-frequency applications.

Do not use alcohol-based products with high-frequency applications.

Do not spray liquids directly onto the articulated arm or immerse it in liquids. The central clamping knob on the articulated arm must be tightened during cleaning/disinfection.



## Material resistance

When selecting cleaning and disinfectant products, ensure that they do not contain the following:

- Organic, mineral or oxidising acids
- Bases
- Organic solvents **that differ from ethanol and isopropanol** (e.g. alcohols, acetone, ether, petrol)
- Oxidising agents (e.g. peroxide)
- Halogens (chlorine, bromine, iodine)
- Aromatic halogenated hydrocarbons
- Oils

When choosing cleaning agents, you should also consider that any ingredients other than ethanol and isopropanol can leave potentially critical residues on the device.

## Control

After cleaning or cleaning/disinfecting, check the function of all product components to ensure trouble-free operation throughout the entire range of motion. In addition, check for corrosion, damaged surfaces, flaking and dirt build-up. Dispose of damaged products (restrictions on reuse, see section on reuse/worn-out product). Products that are still dirty should be cleaned and sanitised again.

## Sterilisation

Do not use sterilisation procedures.

## Packaging

The cleaned and disinfected device should be covered with suitable material, e.g. disposable protective bags, which fulfil the following requirements:

- Foil bag
- Made from a plastic material with low plasticiser content and appropriate cleanliness (at least food grade)

Label the bag with the cleaning and disinfection status.

Packaging is not required if the device is to be used immediately.

## Cleaning and disinfecting the rail clamp and articulated arm

Remove coarse contaminants from the products immediately after use (within a maximum of 2 hours). Wipe all visibly contaminated product surfaces thoroughly with disinfectant wipes.

Consider the following points when selecting cleaning and disinfecting wipes:

Basic suitability for cleaning and sanitising products made of metal or plastic. Approved efficacy (e.g. VAH/DGHM or FDA/EPA approval/authorisation/registration or CE marking). Compatibility with the products (see the "Material resistance" chapter)

Follow the wipe manufacturer's instructions for use and contact time.

### Cleaning and disinfection procedure

1. Remove the disposable cushion (if fitted) from the holder and discard – do not remove fixed cushions (if fitted)
2. Using a clean, soft cloth with warm water (max. 65°C) and a mild, neutral soap solution, gently wipe and wash the parts – avoid excessive amounts of liquid in the areas around screws, threads and fixed cushions (if fitted).
3. Wipe the parts thoroughly with a soft cloth or paper towels
4. The central clamping knob on the articulated arm must be tightened during cleaning/disinfection
5. Wipe all surfaces of the device completely and thoroughly with fresh cleaning and disinfecting wipes. Visibly soiled or dry wipes should no longer be used.
6. Check all surfaces for any remaining visible soiling and repeat the wiping process with fresh wipes if necessary.
7. Check the device (see the "Control" and "Maintenance" chapters).
8. Reassemble the device and repeat the wiping process with a fresh wipe.

### Storage



#### **WARNING!**

Store the products in such a way that they are not damaged

After cleaning, disinfection and complete drying, store the device in its protective packaging in a dry and dust-free place.

These storage conditions are not necessary if the device is stored directly at the point of use and used immediately.

### Reuse/worn-out product

The products can be reused for 5 years if they have not been damaged and have been cleaned and disinfected in accordance with the above instructions. Any reuse beyond 5 years and the use of damaged or dirty products is at the user's own risk. If a damaged product is used or if a product is reused without being cleaned and disinfected, the company accepts no liability for any damage caused.

In the event of non-compliance, any liability for damages is excluded.



## Storage, handling and transport

### WARNING!



Store the products in such a way that they are not damaged

The product must be stored and transported in dry conditions in the original packaging at room temperature and not exposed to direct sunlight. Improper storage and transport can affect product properties and lead to failure.

## Maintenance

No special maintenance is required. If the moving parts have reduced mobility, the clamping force is impaired or in case of damage, the product must be returned to the manufacturer or dealer.

### Never use instrument oil or grease.



warranty.

### NOTE

Repairs may only be carried out by the manufacturer. Failure to observe this will void the



### NB!

Only cleaned and sanitised products may be returned to the dealer/manufacturer for repair. Download the disinfection declaration at [www.opitek-international.dk](http://www.opitek-international.dk)

## Disposal

Products must be disposed of properly according to applicable national regulations and medical guidelines.

## Disclaimer of warranty and limitation of remedy

No express or implied warranty, including without limitation, any implied warranty of merchantability or fitness for a particular purpose, is granted on the Opitek International products described in this publication. In no event shall Opitek International be liable for any direct, indirect or consequential damages, except as expressly provided by specific legislation. No person is authorised to bind Opitek International to any representation or warranty except as specifically stated herein.

The description or specifications in Opitek International printed matter, including this publication, are intended solely for the general description of the product at the time of manufacture and do not constitute an express warranty.

Opitek International shall not be liable for any direct, indirect or consequential damages resulting from improper use. This is based on Opitek International's estimates.





## DECLARATION OF CONFORMITY

**We, the manufacturer,**

Opitek International ApS, Gøngehusvej 252, 2950 Vedbæk, Denmark  
(Org. number / EORI number: 30554582 - SRN: DK-MF-000001594)

**declare that the following product(s):**

Product name	Item number	UDI-DI
Flex Fix with fixed support cushion	2024-01	05714834004336
Flex Fix for disposable support cushion	2024-200	05714834004350
Upgrade from a fixed to disposable cushion	2024-100	05714834004343
Upgrade from a disposable to fixed cushion	2024-150	05714834004367
Disposable cushion	2015-02	05714834001373
Reusable cushion (incl. 2 screws)	2000-02	05714834001069

**Basic UDI-DI: 0571483400400TX**

**Complies with the provisions of the following:**

**Regulation (EU) 2017/745 of the European Parliament and of the Council of 5 April 2017 on medical devices, amending Directive 2001/83/EC, Regulation (EC) No. 178/2002 and Regulation (EC) No. 1223/2009 and repealing Council Directives 90/385/EEC and 93/42/EEC**  
**Classification according to Annex VIII, Chapter III, 4.1**

**Medical devices, class I: Non-invasive devices**

**Description of the product:**

The brand name of the device is **Opitek Flex Fix**. The generic device name is **universal flexible positioning device**.

Before and during a surgical procedure, Flex Fix allows the surgical team to flexibly, yet precisely and stably, position the patient on the operating table.

Flex Fix can be used on patients in supine, lateral, lithotomy or prone position, as well as for (arm) support for assisting staff (e.g. speculum or scope restraint procedures)

**Certified according to, and in compliance with, the provisions of Annex II and III**

**Issued under the manufacturer's responsibility**

**Location:** Vedbæk, Denmark **Date:** 15 April 2024

Peter Christensen  
CEO, Managing Director  
Opitek International ApS







**Comments and notes:**

---

---

---

---

---

---

---

---

---

---

---

---

---

---

---

---

---

---

---

---

---

---

---

---

---

---



# opitek